

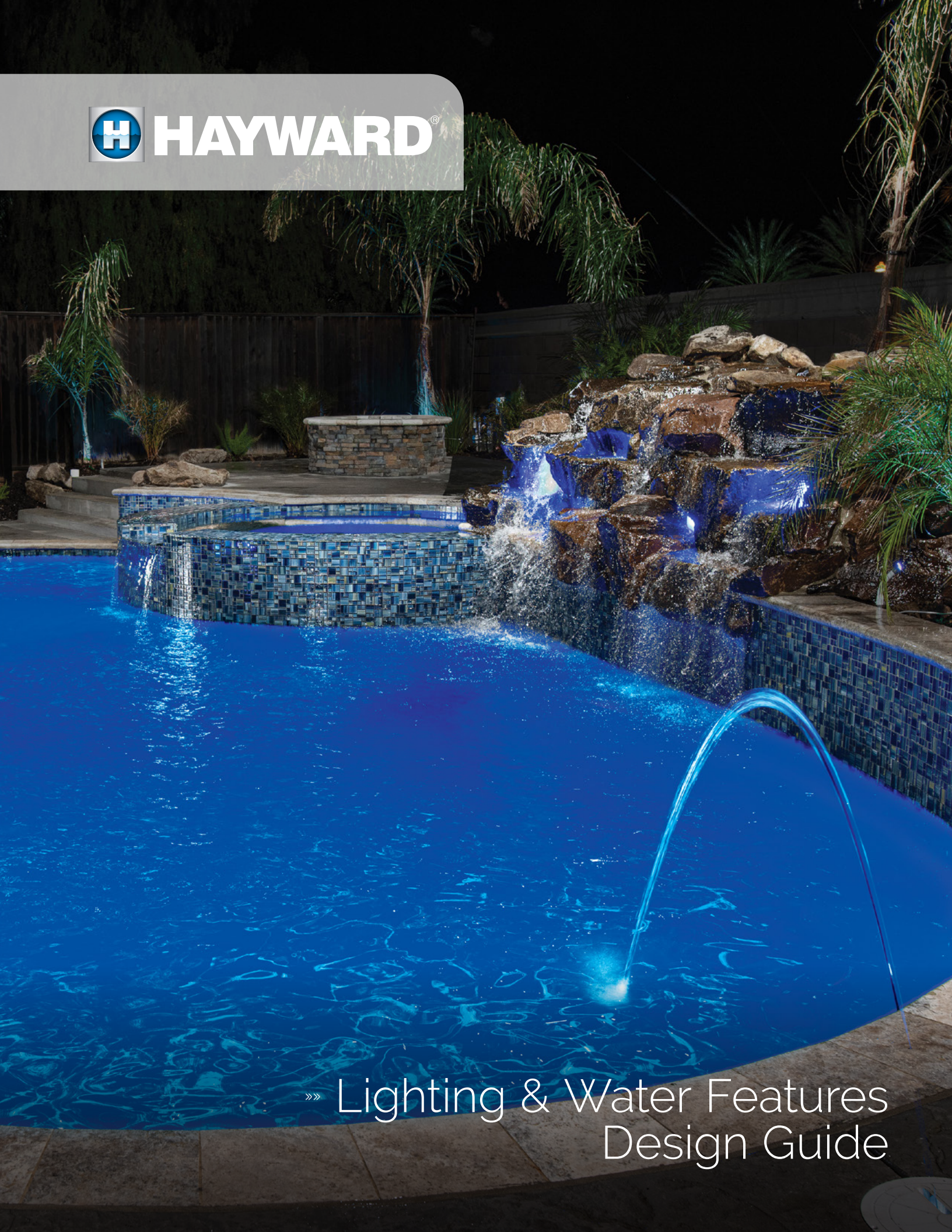

**HAYWARD**<sup>®</sup>



»» Lighting & Water Features  
Design Guide

---

## Discover the best and brightest ways to enhance any backyard.

---

Hayward® ColorLogic® LED pool, spa and backyard lights are designed to illuminate nearly any new or existing pool or spa environment with vibrant color. With a variety of size options available, it's easy to highlight any outdoor feature while reducing energy costs by up to 86%. Discover how this brilliant family of lighting can transform any backyard environment into an oasis of color.

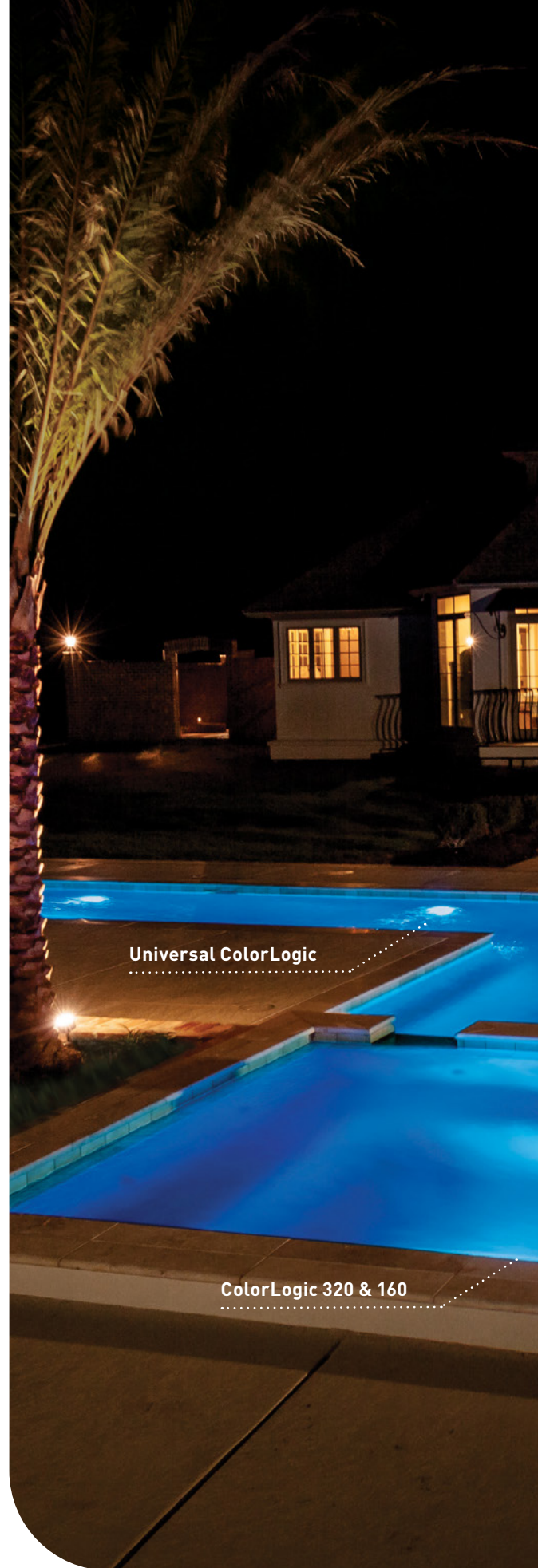

Universal ColorLogic

ColorLogic 320 & 160



ColorLogic 80 & 40

ColorLogic 80

# Lighting Overview



## MINIMUM ILLUMINANCE

- » Depending on the local health code, incandescent lights were historically required to provide 0.5 or 1 watt per square foot of pool surface area
- » Today, most health departments and the Model Aquatic Health Code suggest 8-9 lumens per square foot
- » This value only applies to lights using a **white** wavelength

## CALCULATE NUMBER OF LIGHTS NEEDED

$$\text{Number of Lights} = \frac{\text{Pool Surface Area} \times 8 \text{ Lumens}}{\text{Lumen Output of Light}}$$



## LIGHTING PLACEMENT

- » **Beam pattern:** The angular spread of light emitted from the fixture
- » The beam pattern is measured between points on opposite sides of the beam axis where the intensity drops to 50% of maximum power
- » X-axis: Horizontal spread
- » Y-axis: Vertical spread

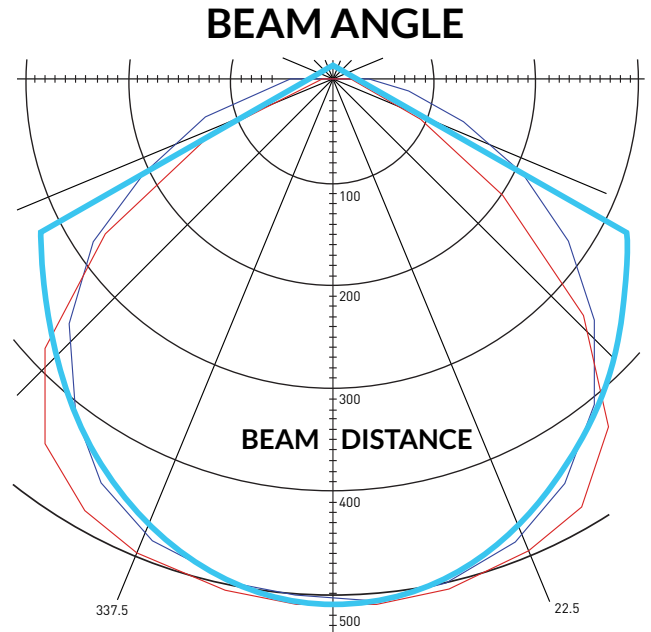

## TRANSFORMER REQUIREMENTS

PRODUCT	PART NUMBER	WATTS	MAX LIGHTS PER 70W J-BOX TRANSFORMER	MAX LIGHTS PER 140W (2/70) TRANSFORMER	MAX LIGHTS PER 300W TRANSFORMER (USE 14V)	AMPS
UCL ColorLogic® Pool Light	LPCUS/LPCUN	70	1	2	3	5
UCL ColorLogic Spa Light	LSCUS/LSCUN	35	2	4	9	2.5
1.5" ColorLogic 320	LACUS	23	3	5	9	1.64
1.5" ColorLogic 180	LYCUS	13	3	5	15	0.93
0.5" ColorLogic 80	LMCUS	2.6	8	12	15	0.2
0.5" ColorLogic 40	LNCUS	1.3	15	20	25	0.1
ColorLogic 80 & 40 Driver (Up to 5 lights per driver)	LMCUSPS	13 (80s)	2 Drivers (10 Lights)	4 (2+2 Drivers) (20 Lights)	13 Drivers (65 Lights)	1 (80s)
		6.5 (40s)				0.5 (40s)
UCL CrystaLogic® Pool Light (500W Equivalent)	LPWUS	70	1	2	3	5.4
UCL CrystaLogic Pool Light (300W Equivalent)	LPLUS	70	1	2	3	5
UCL CrystaLogic Pool Light (100W Equivalent)	LSLUS	35	1	2	6	2.5
1.5" CrystaLogic 320	LAWUS	25	2	5	6	1.78
1.5" CrystaLogic 160	LYWUS	15	3	5	6	1.07

# Universal ColorLogic



Universal ColorLogic LED lights are the most energy-efficient way to deliver spectacular color to pools of all kinds. As the industry's only UL-listed lights to retrofit virtually any existing pool or spa, and with no bonding or grounding requirements, they're the perfect fit for any backyard environment.

## LUMEN OUTPUT

PRODUCT	COLOR: WHITE
Universal ColorLogic Pool	2600 lms
Universal CrystaLogic Pool (300W Equiv.)	3300 lms
Universal CrystaLogic Pool (500W Equiv.)	4900 lms
Universal ColorLogic Spa	700 lms
Universal CrystaLogic Spa	1100 lms

## BEAM PATTERN

PRODUCT	X-AXIS	Y-AXIS
Universal ColorLogic Pool	135°	65°
Universal CrystaLogic Pool	135°	65°
Universal ColorLogic Spa	135°	45°
Universal CrystaLogic Spa	135°	45°

## INSTALLATION DEPTH

Universal ColorLogic lights are UL-listed for use in pool and spa walls or floors (without guards). The top of the lens should be no less than 4" (10 cm) below normal water level.



## FEATURES

- » 10 fixed colors and 7 color-changing shows
- » 100% brighter than any other lights on the market
- » Trim rings available in multiple colors
- » All-plastic, low-voltage design
- » Can be installed in as little as 4" below the waterline and on walls or floors without rock guards
- » Brightness, dimming, speed control and 10 additional colors available when paired with Hayward®'s OmniLogic® or OmniHub® automation systems



## APPLICATIONS

- » Pools
- » Spas



\* Compared with incandescent lights

# ColorLogic 320 & 160



ColorLogic® 320 & 160 1.5-inch LED lights are ideal for discreet, uniform pool and spa lighting or for highlighting various backyard features. Available in two brightness levels and able to be installed wet or dry, these versatile UL-listed lights can meet the needs of any backyard application.

## LUMEN OUTPUT

PRODUCT	COLOR: WHITE
ColorLogic 320	640 lms
CrystaLogic® 320	1100 lms
ColorLogic 160	333 lms
CrystaLogic 160	6000 lms

## BEAM PATTERN

PRODUCT	X-AXIS	Y-AXIS
ColorLogic 320	160°	160°
CrystaLogic 320	160°	160°
ColorLogic 160	160°	160°
CrystaLogic 160	160°	160°

## INSTALLATION DEPTH

ColorLogic 320 & 160 lights are UL-listed for wet or dry use within a 10' radius of the pool. For wet use, the lights are listed for both in-wall and on-floor applications (without the use of a guard). When submerged, the top of the lens should be no less than 4" (10 cm) below normal water level.



## ✓ FEATURES

- » Sync with 12V ColorLogic light family, offering 10 fixed colors and 7 color-changing light shows
- » Low-profile installations for vinyl, fiberglass and concrete applications
- » UL-listed to ensure safe installation in wet or dry applications

## 🔧 APPLICATIONS

- » Pools
- » Spas
- » Fountains
- » Uplighting
- » Water features
- » Baja shelves
- » Step lighting
- » Hardscape/landscape

# ColorLogic 80 & 40



ColorLogic 80 & 40 0.5-inch LED lights offer dynamic illumination of water and landscape features in a compact size that's perfect for hard-to-illuminate areas. They also have the ability to synchronize with Universal ColorLogic colors and light shows, allowing your creativity to shine.

## LUMEN OUTPUT

PRODUCT	COLOR: WHITE
ColorLogic 80	165 lms
ColorLogic 40	83 lms

## BEAM PATTERN

PRODUCT	X-AXIS	Y-AXIS
ColorLogic 80	160°	160°
ColorLogic 40	160°	160°

## INSTALLATION DEPTH

ColorLogic 80 & 40 lights are UL-listed for wet, dry and landscape use. For wet use, the lights are listed for both in-wall and on-floor applications (without the use of a guard). When submerged, the top of the lens should be no less than 2" (5 cm) below normal water level. A direct burial cord is required for landscape use.

## DRIVER REQUIRED

Lights require LMCUSPS005 ColorLogic Driver for operation. Each driver can operate up to five lights.



## ✓ FEATURES

- » Sync with 12V ColorLogic light family, offering 10 fixed colors and 7 color-changing light shows
- » High and standard lumen models available for multiple brightness levels
- » UL-listed to ensure safe installation in wet or dry applications
- » No bonding or grounding required

## 🔧 APPLICATIONS

- » Pools
- » Spas
- » Fountains
- » Uplighting
- » Rock waterfalls
- » Water features
- » Sun shelves
- » Step lighting
- » Hardscape/landscape
- » Decking





# Lighting Placement

Lighting effects should always be noticeable, but never at the source of the light. Lights should face away from the house whenever possible in order to eliminate obtrusive light and prevent glare. By overlaying the beam pattern data provided in this guide, optimal light placement can be determined for uniform coverage.

## RECOMMENDED SPACING

Accurate spacing is critical to ensure sufficient water illumination. While the number of lights may be selected based on the required lumens per square foot, designing to the minimum may not achieve the desired lighting ambiance.

The values below represent the recommended range for average uniform coverage based on beam width.

TYPICAL SPACING	
PRODUCT	DISTANCE
Universal ColorLogic® Pool	14'
Universal CrystaLogic® Pool	14'
Universal ColorLogic Spa	7'-9'
Universal CrystaLogic Spa	7'-9'
ColorLogic 4.0 Pool	10'-13'
ColorLogic 4.0 Spa	7'-9'
ColorLogic 320	5'-7'
CrystaLogic 320	5'-7'
ColorLogic 160	5'-7'
CrystaLogic 160	5'-7'
ColorLogic 80	2'-3'
ColorLogic 40	2'-3'

## RECOMMENDED SETBACK

Setback refers to how far a light source is placed from a wall or other area it's illuminating. For uplighting, the setback distance will vary based on the illumination height—the higher the wall, the more setback required. The lower the setback, the greater the light intensity will be at the base of the wall.

The values below represent the recommended range for average uniform coverage based on wall height.

TYPICAL SETBACK		
PRODUCT	DISTANCE	HEIGHT
Universal ColorLogic Pool	3'	20'
Universal CrystaLogic Pool	3'	20'
Universal ColorLogic Spa	1'	10'
Universal CrystaLogic Spa	1'	10'
ColorLogic 4.0 Pool	3'	15'
ColorLogic 4.0 Spa	1'	10'
ColorLogic 320	2'	10'
CrystaLogic 320	2'	10'
ColorLogic 160	2'	10'
CrystaLogic 160	2'	10'
ColorLogic 80	1'	5'
ColorLogic 40	1'	5'

---

# Lighting Design

---

## GENERAL DESIGN CONSIDERATIONS

- » Lights should be aimed at the feature you wish to highlight, but the direct source should not be visible
- » Spacing lights too far apart can create dark spots—place lights closer together to eliminate shadows
- » Avoid placing lights too close to walls, as this can result in glare-producing “hotspots;” refer to setback chart for recommended distances
- » Consider surface finishes—lighter finishes will reflect better, requiring fewer lights, while dark surfaces will need more lights to achieve a similar effect

## SPECIFIC DESIGN CONSIDERATIONS

- » For irregularly shaped pools, using smaller lights in multiples can improve uniformity
- » Using 0.5” lighting to illuminate landscaping creates dramatic focal points
- » Indirectly illuminate one or more pool steps by projecting light from the adjacent wall perpendicular to the steps

---

## INSTALLATION TIPS

- » Lights can easily be hidden under or behind rocks or within conduits—this is especially helpful when lighting water features and landscaping
- » Flexible PVC pipe can be used for easy conduit routing
- » In certain applications, it may be useful to secure lights using conduit to keep the focal point of the light fixed
- » For 45” landscape fixtures, the setback distance should be 3-4” or less
- » When used in landscape applications, ColorLogic® 320, 160, 80 & 40 lights are designed to be mounted in standard PVC or copper piping. Custom landscape fixtures can be produced using industry-standard pipe fittings
- » Because of their small size, ColorLogic 80 & 40 lights can be retrofitted into most landscape lighting fixtures with minor modifications

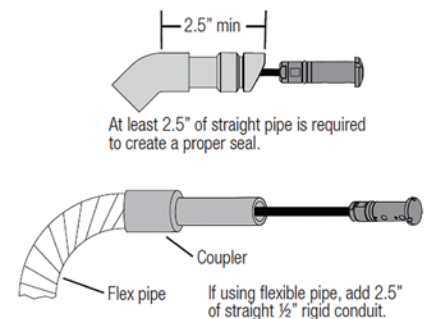



---

## Create the perfect ambiance with the tranquility of moving water.

---

The simple beauty of moving water has the ability to transform any pool environment into a true oasis. With thoughtful design and industry-leading construction, Hayward® water features seamlessly blend into any backyard, while subtly and elegantly enhancing its natural beauty. From relaxing afternoon lounging to lively evening parties, Hayward offers water features that complement any style.

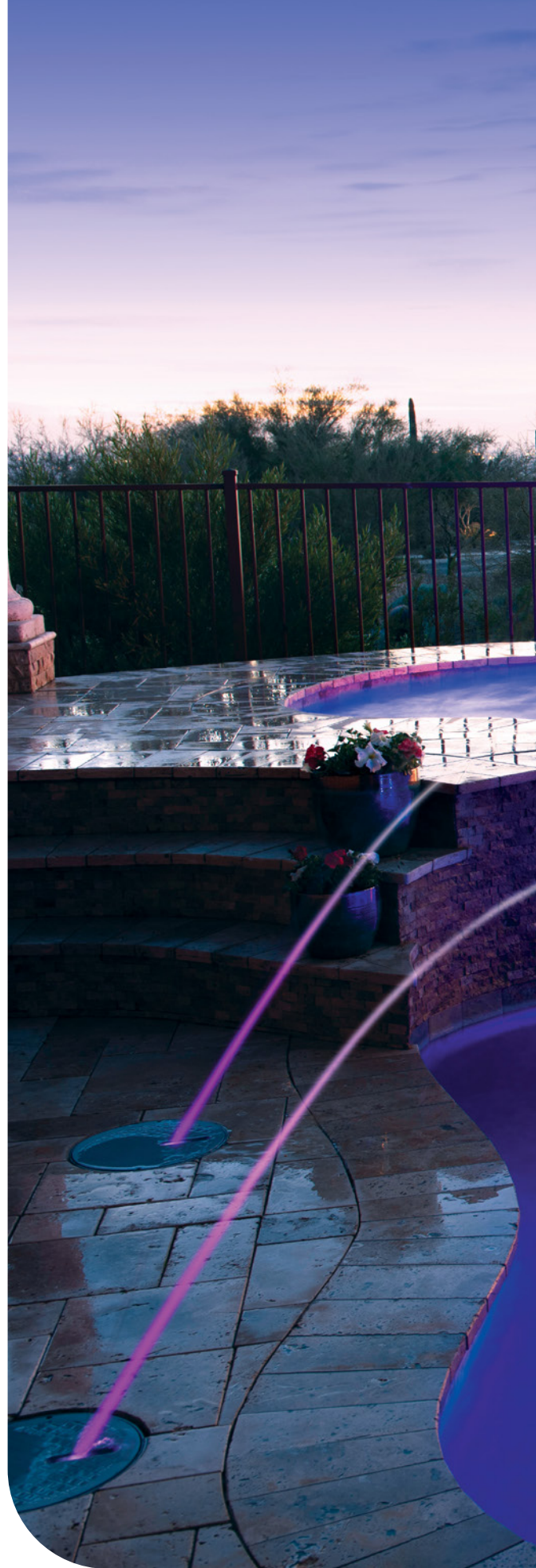



---

# ColorLogic Laminar

---



Designed for easy installation and use, ColorLogic® Laminars are the simple way to add unparalleled visual and acoustic appeal to any pool or spa. Their peaceful, glass-like arcs of water catch the sunlight during the day and transform into vibrant streams of color after dark.

---

## ILLUMINATION

ColorLogic Laminar can be illuminated using CrystaLogic® or ColorLogic 320 & 160 lights. The disruptor stream can also be adjusted to increase rod illumination.

---

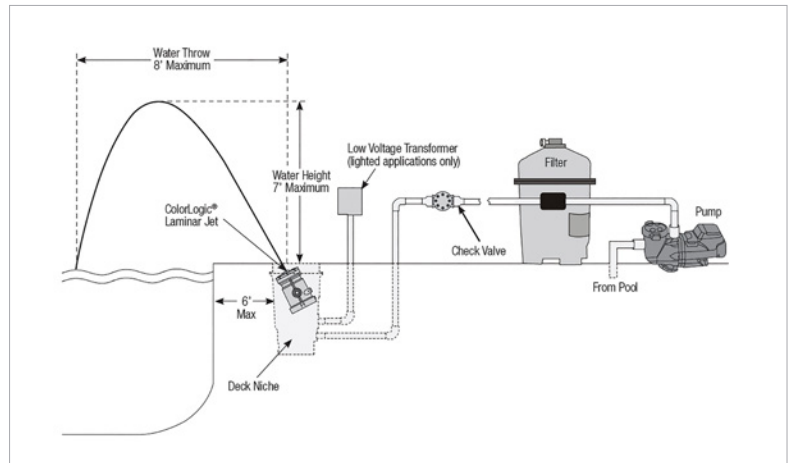

## ✓ FEATURES

- » Integrated flow control
  - » Compact design
  - » Height-adjustable cover ensures perfect alignment, even after settling
  - » Fully serviceable for simple winterization and cleaning
  - » Locking angle adjustment
- 

## 🔧 APPLICATIONS

- » Deck/patio
- » Garden planter
- » Concrete



# ColorLogic Bubbler



ColorLogic Bubbler creates a cascading column of water and ensures the ultimate backyard ambiance when paired with Hayward®'s ColorLogic lighting. A small footprint and flush design make for a smooth integration into any backyard environment.

## PLUME HEIGHT – 3/4" NOZZLE ORIFICE

GALLONS PER MINUTE (GPM)	DEPTH				
	4"	6"	8"	10"	12"
15 GPM	11	8	5	4.5	3.5
20 GPM	15	10	7	6	5
25 GPM	24	16	11	9	8
30 GPM	35	21	17	12	10.5
35 GPM	45	30	20.5	15	13
40 GPM	--	37.5	27	20	15

## PLUME HEIGHT – 1/2" NOZZLE ORIFICE

GALLONS PER MINUTE (GPM)	DEPTH				
	4"	6"	8"	10"	12"
10 GPM	31	16	--	--	--
15 GPM	48	26	15.5	12	10
20 GPM	75	43	25	19	15

## ILLUMINATION

ColorLogic Bubbler can use either CrystaLogic or ColorLogic 320 & 160 for illumination. A ColorLogic 320 is recommended for depths greater than 4".



## FEATURES

- » Synchronize with CrystaLogic or ColorLogic 320 & 160 lighting for a wide variety of options
- » Easily adjustable water heights and widths
- » Interchangeable color trim options



## APPLICATIONS

- » Sun shelves/tanning ledges
- » Spas
- » Fountains
- » Splash pads



---

# Sheer 500

---



Sheer 500 is customizable to any pool and creates a tranquil waterfall effect that will enhance any backyard. Rear and bottom connection options make installation quick and simple anywhere.

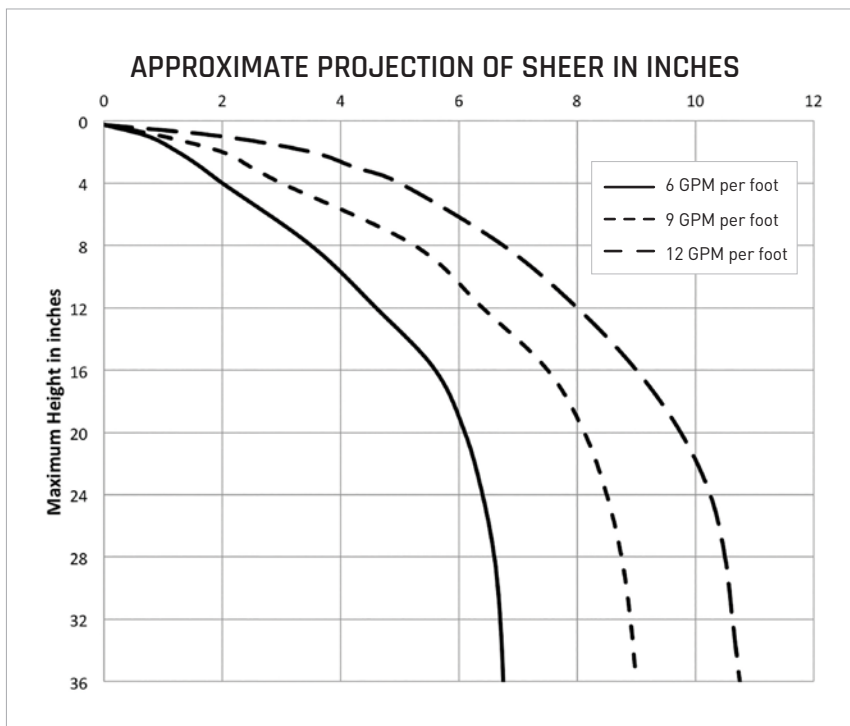

---

## ILLUMINATION

Sheer 500 can be illuminated using any of the ColorLogic® product family. For uniform illumination, uplighting of the sheer feature is recommended.

---

## ✓ FEATURES

- » Combine with Hayward®'s LED lighting to create a unique blend of color with the beauty of falling water
  - » Can be installed in straight or curved applications
  - » Rear and bottom connection options make installation simple
  - » 1.5" x 2" connections are compatible with larger plumbing while also maximizing water flow
- 

## 🔧 APPLICATIONS

- » Pools
- » Spas
- » Fountains





# Deck Jet 500



Deck Jet 500 creates an arching stream of water from deck to pool and offers simple flow and direction adjustment without the use of tools. With the industry's only height-adjustment mechanism, perfect deck alignment is ensured, even after settling.

## ARC HEIGHT

A (DEGREE)	FLOW RATE (GPM)		X (FEET)		Y (FEET)		HEAD LOSS (FT. OF HEAD)	
	MAX OPEN	MIN OPEN	MAX OPEN	MIN OPEN	MAX OPEN	MIN OPEN	MAX OPEN	MIN OPEN
60	3	2.3	4	2.6	3.7	3	4.3	4.5
	4	3.1	6.4	4	5.2	3.9	6.3	6.8
	5	3.9	9.6	5.6	6.9	4.9	8.4	8.9
80	3	2.9	1.8	1.3	4.2	3.9	4.3	4.3
	4	3.9	2.4	2.3	5.8	5.3	6.3	6.4
	5	4.8	3	2.9	8.2	7.3	8.4	8.5

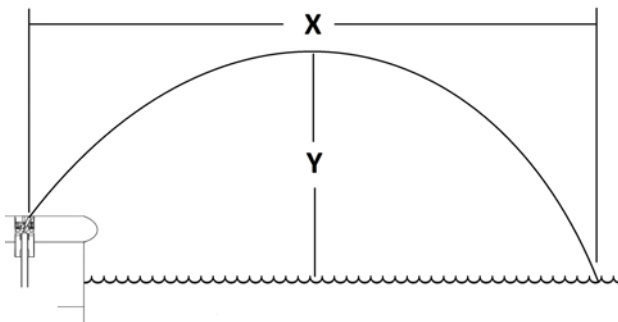

## ILLUMINATION

Deck Jet 500 can be illuminated using any of the ColorLogic product family. For uniform illumination, uplighting of the deck jet feature is recommended.

## ✓ FEATURES

- » ColorLogic 80 & 40 lights can be positioned upward-facing in the deck under the deck jet stream to enhance performance at night
- » Elevates the visual and acoustic appeal of pool surroundings
- » Complete control of the height and distance of the water stream without tools
- » Simple integrated flow adjustment can eliminate the need for dedicated valves for each deck jet

## 🔧 APPLICATIONS

- » Sun shelves/tanning ledges
- » Spas
- » Fountains
- » Splash pads



---

## OmniDirect Mode

---

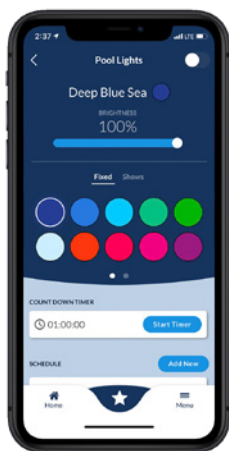

Access additional capabilities with OmniDirect Mode™ by pairing low-voltage ColorLogic® standalone lights with Omni® automation. OmniDirect Mode offers full backyard control right from a phone or tablet and popular voice control systems, as well as access to more features than ColorLogic offers alone.

### ✓ FEATURES

- » Instant navigation to desired colors or light shows (no more cycling through every option)
- » Dimming capabilities (20% increments)
- » Speed adjustment for light shows
- » Ability to set schedules or timers
- » Access to 10 additional colors for increased customization opportunities (special occasions, sports teams, school colors and more)

---

## ColorLogic Light Controller

---



ColorLogic Light Controller puts the power of colorful, customizable low-voltage ColorLogic LED lighting at your fingertips. As the only wall controller that can be easily installed into an existing light switch, it's never been easier to choose the perfect backyard setting.

### ✓ FEATURES

- » Instantly view and choose from 10 fixed colors and 7 color-changing light shows
- » Turn pool, spa and backyard lights on or off with the push of a button
- » Ability to set timers or schedules
- » Innovative preview window displays the color or light show
- » Can easily retrofit into an existing light switch







### ✂ INSTALLATION TIPS

- » If retrofitting in an existing light switch, gang box must be a minimum of 14in<sup>3</sup>/2.75" deep
- » For indoor or protected outdoor use
- » For outdoor installations, a UL-approved outdoor rated box is required
- » ColorLogic Light Controller **only** works with:
  - » Hayward® Universal ColorLogic 12V LED pool & spa lights
  - » Hayward ColorLogic 320, 160, 80, 40 12V LED lights

# ColorLogic Spectrum

ColorLogic LED lights come with 10 fixed colors and 7 color-changing light shows, plus even more options when paired with Hayward Omni automation, so it's easy to set the mood for any occasion.

## LIGHT SHOWS

-  **VOODOO LOUNGE**
-  **USA**
-  **TWILIGHT**
-  **MARDI GRAS**
-  **TRANQUILITY**
-  **COOL CABARET**
-  **GEMSTONE**

## ADDITIONAL LIGHT SHOWS

*When integrated with Hayward automation*

-  **RAINBOW**
-  **HARMONY**
-  **CUSTOM FADE**
-  **CUSTOM CHASE**

## 10 FIXED COLORS

- Deep Blue Sea
- Royal Blue
- Afternoon Skies
- Aqua Green
- Emerald
- Cloud White
- Warm Red
- Flamingo
- Vivid Violet
- Sangria

Additional colors available when paired with Hayward automation:

- Teal
- Mint
- Yellow
- Bright Yellow
- Gold
- Pure White
- Crisp White
- Warm White
- Orange
- Burnt Orange





» [hayward.com](http://hayward.com) » 1-800-657-2287

Pumps » Filters » Heating » Cleaners » Sanitization » Automation » Lighting » Safety » White Goods

Hayward, Hayward & Design, the H logo, ColorLogic, CrystaLogic, OmniHub, OmniLogic, and ProLogic are registered trademarks and OmniDirect Mode is a trademark of Hayward Industries, Inc. All other trademarks not owned by Hayward are the property of their respective owners. Hayward is not in any way affiliated with or endorsed by those third parties. © 2020 Hayward Industries, Inc.



DLITLEDWFDG20